



AUDIO PROCESSOR

■ GENERAL DESCRIPTION

The **NJW1165** is an audio processor. It includes all of functions processing audio signal for TV, such as tone control, balance, volume, mute, NJRC original surround, and AGC functions.

The NJRC original surround system reproduces natural surround sound and clear vocal orientation.

All of internal status and variables are controlled by I²C BUS interface.

■ PACKAGE OUTLINE

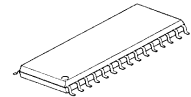
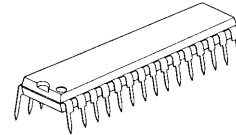

NJW1165L

NJW1165M

■ FEATURES

- Operating Voltage 7.5 to 13V
- I²C BUS Interface
- eala (NJRC Original Surround)
- AGC Circuit (It reduces volume difference among input sources.)
- Simulated Surround
- Bi-CMOS Technology
- Package Outline SDIP30, SDMP30

■ BLOCK DIAGRAM

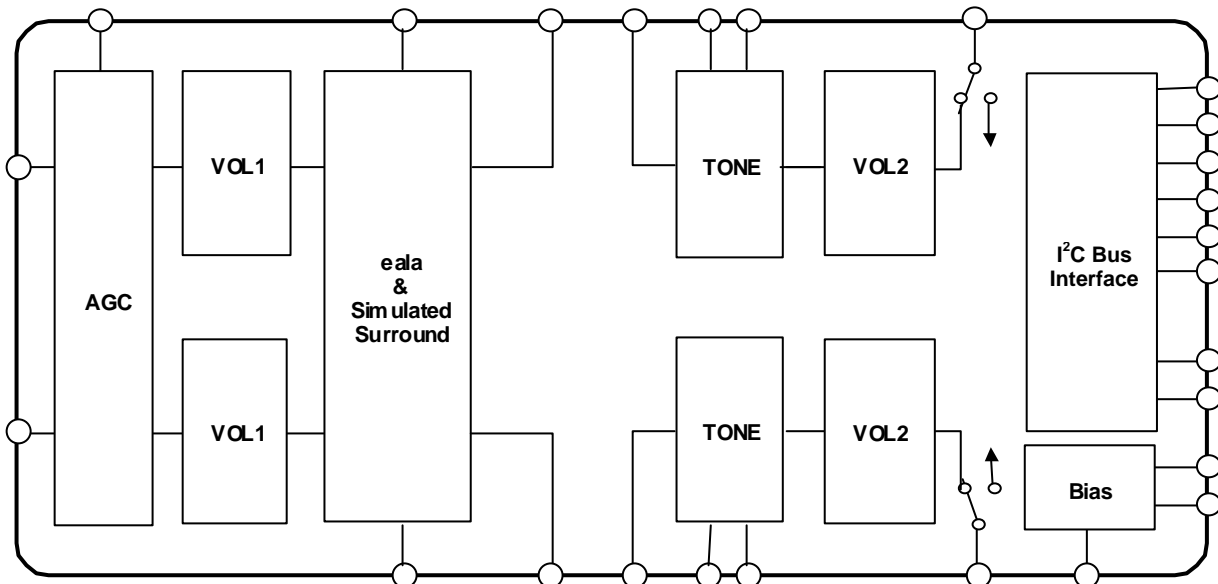

■ PIN FUNCTION

1	INa	INb	30
2	NC	NC	29
3	NC	NC	28
4	OUT1a	OUT1b	27
5	IN2a	IN2b	26
6	TONE-Ha	TONE-Hb	25
7	TONE-La	TONE-Lb	24
8	OUT2a	OUT2b	23
9	AGC	SR-FIL	22
10	SS-FIL	VREF	21
11	CVB	CTH	20
12	CVA	CTL	19
13	SDA	AUX0	18
14	SCL	AUX1	17
15	GND	Vcc	16

No.	Symbol	Function	No	Symbol	Function
1	IN1a	Ach Input	16	Vcc	Power Supply Pin
2	NC	Non Connect	17	AUX1	Auxiliary Output1
3	NC	Non Connect	18	AUX0	Auxiliary Output0
4	OUT1a	Ach Output for the Other Accessories	19	CTL	Pop Noise reduction for Bass Control
5	IN2a	Ach Input From the Other Accessories	20	CTH	Pop Noise reduction for Treble Control
6	TONE-Ha	Ach Treble Filter	21	VREF	Reference Voltage
7	TONE-La	Ach Bass Filter	22	SR-FIL	NJRC Original Surround Filter
8	OUT2a	Ach Output	23	OUT2b	Bch Output
9	AGC	AGC Filter	24	TONE-Lb	Bch Bass Filter
10	SS-FIL	Simulated Stereo Filter	25	TONE-Hb	Bch Treble Filter
11	CVB	Pop Noise Reduction for Volume & Balance	26	IN2b	Bch Input from the Other Accessories
12	CVA	Pop Noise Reduction for Volume & Balance	27	OUT1b	Bch Output for the Other Accessories
13	SDA	SDA Data Input (I ² C BUS)	28	NC	Non Connect
14	SCL	SCL Data Input (I ² C BUS)	29	NC	Non Connect
15	GND	GND	30	IN1b	Bch Input

■ ABSOLUTE MAXIMUM RATING (Ta=25°C)

PARAMETER	SYMBOL	RATING	UNIT
Supply Voltage	V ⁺	15	V
Power Dissipation	P _D	700	mW
Operating Temperature Range	Topr	-20 to +75	°C
Storage Temperature Range	Tstg	-40 to +125	°C

■ ELECTRICAL CHARACTERISTICS

(Ta=25°C, V+=9V, Rg=600Ω, RL=47kΩ, Vin=100mVrms/1kHz unless otherwise specified)

PARAMETER	SYMBOL	TEST CONDITION	MIN.	TYP.	MAX.	UNIT
Operating Voltage	V ⁺		7.5	9.0	13.0	V
Supply Current	I _{CC}	No Signal	-	13	25	mA
Reference Voltage	V _{REF}	No Signal	4.0	4.5	5.0	V
Maximum Input Voltage	V _{IM}	VOL=-20dB, THD=1%	2.8	3.0	-	Vrms
Maximum Output Voltage	V _{OM}	OUTPUT VOL=0dB, THD=1%	-	2.5	-	Vrms
Channel Balance1	G _{CB}	VOL=0dB	-1.5	0.0	1.5	dB
Balance Boost A	BA _{BST}	CHS="0", BAL="11111"	-2.0	0.0	2.0	dB
Balance Cut A	BA _{CUT}	CHS="1", BAL="11111" Vin = 1Vrms	-	-	-70	dB
Balance Boost B	BB _{BST}	CHS="1", BAL="11111"	-2.0	0.0	2.0	dB
Balance Cut B	BB _{CUT}	CHS="0", BAL="11111" Vin = 1Vrms	-	-	-70	dB
Total Harmonic Distortion	THD	Vo=0.5Vrms BW=400Hz to 30kHz	-	-	0.5	%
Maximum Gain	G _{VMAX}	VOL= 0dB	-2.0	0.0	2.0	dB
Minimum Gain	G _{VMIN}	VOL= MUTE	-	-	-70	dB
Channel Separation	CS	Vin = 2Vrms Ain → Bout, Bin → Aout	-	-	-70	dB
Output Noise 1	V _{NO1}	VOL = 0dB BW=400Hz to 30kHz	-	-90 (31.6)	-85 (56.2)	dBV (μVrms)
Output Noise 2	V _{NO2}	VOL = MUTE BW = 400Hz to 30kHz	-	-106 (5.0)	-96 (15.8)	dBV (μVrms)
AUX Output Voltage	V _{AUX}	Logic Output: High	4.5	-	5.0	V
		Logic Output: Low	0	-	0.3	

BW: Band Width

◆ TONE CONTROL

PARAMETER	SYMBOL	TEST CONDITION	MIN.	TYP.	MAX.	UNIT
High Frequency Boost	HF _{BST}	BCT="1", TREB="1111", f=10kHz	12.5	15.0	17.5	dB
High Frequency Flat	HF _{FLT}	TRBE="0000", f=10kHz	-2.0	0.0	2.0	dB
High Frequency Cut	HF _{CUT}	BCT="0", TRBE="1111", f=10kHz	-17.5	-15.0	-12.5	dB
Low Frequency Boost	LF _{BST}	BCB="1", BASS="1111", f=100Hz	12.5	15.0	17.5	dB
Low Frequency Flat	LF _{FLT}	BASS="0000", f=100Hz	-2.0	0.0	2.0	dB
Low Frequency Cut	LF _{CUT}	BCB="0", BASS="1111", f=100Hz	-17.5	-15.0	-12.5	dB

◆ SUB-TONE CONTROL

PARAMETER	SYMBOL	TEST CONDITION	MIN.	TYP.	MAX.	UNIT
High Frequency Boost	SHF _{BST}	BCST="1", SUB-TREB="11", f=10kHz	2.0	3.0	4.0	dB
High Frequency Cut	SHF _{CUT}	BCST="0", SUB-TREB="11", f=10kHz	-4.0	-3.0	-2.0	dB
Low Frequency Boost	SLF _{BST}	BCSB="1", SUB-BASS="11", f=100Hz	2.0	3.0	4.0	dB
Low Frequency Cut	SLF _{CUT}	BCSB="0", SUB-BASS="11", f=100Hz	-4.0	-3.0	-2.0	dB

◆ AGC CONTROL

PARAMETER	SYMBOL	TEST CONDITION	MIN.	TYP.	MAX.	UNIT
AGC Boost	AGC _{BST}	Vin=50mVrms, f=1kHz	1.5	3.5	5.5	dB
AGC Flat1	AGC _{FLT1}	Vin=150mVrms, f=1kHz	-2.5	0.0	2.5	dB
AGC Flat2	AGC _{FLT2}	Vin=300mVrms, f=1kHz	-2.5	0.0	2.5	dB
AGC Flat3	AGC _{FLT3}	Vin=400mVrms, f=1kHz	-2.5	0.0	2.5	dB
AGC Flat4	AGC _{FLT4}	Vin=540mVrms, f=1kHz	-2.5	0.0	2.5	dB
AGC Cut	AGC _{CUT}	Vin=2Vrms, f=1kHz	-14	-10	-6.0	dB

◆ SURROUND (SURROUND-ON)

PARAMETER	SYMBOL	TEST CONDITION	MIN.	TYP.	MAX.	UNIT
Surround Gain1	SR _{GAIN1}	Ain→Aout, f=100Hz SUR0="0", SUR="1"	6.0	8.0	10.0	dB
Surround Gain2	SR _{GAIN2}	Ain→Bout, f=100Hz SUR0="0", SUR="1"	1.6	3.6	5.6	dB
Surround Gain3	SR _{GAIN3}	Ain→Aout, f=100Hz SUR0="1", SUR="1"	10.7	12.7	14.7	dB
Surround Gain4	SR _{GAIN4}	Ain→Bout, f=100Hz SUR0="1", SUR="1"	8.4	10.4	12.4	dB
Simulated Surround Gain1	SR _{SIM1}	Ain+Bin→Aout, f=1kHz SUR0="1", SUR="0"	1.0	3.0	5.0	dB
Simulated Surround Gain2	SR _{SIM2}	Ain+Bin→Bout, f=1kHz SUR0="1", SUR="0"	1.0	3.0	5.0	dB

■ I²C BUS BLOCK CHARACTERISTICS (SDA, SCL)

PARAMETER	SYMBOL	MIN.	TYP.	MAX.	UNIT
High Level Input Voltage	V _{IH}	2.5	-	5.0	V
Low Level Input Voltage	V _{IL}	0	-	1.5	V
High Level Input Current	I _{IH}	-	-	10	μA
Low Level Input Current	I _{IL}	-	-	10	μA
Low Level Output Voltage (3mA at SDA pin)	V _{OL}	0	-	0.4	V
Maximum Output Current	I _{OL}	-3.0	-	-	mA
Maximum Clock Frequency	f _{SCL}	-	-	100	kHz
Data Change Minimum Waiting Time	t _{BUF}	4.7	-	-	μs
Data Transfer Start Minimum Waiting Time	t _{HD:STA}	4.0	-	-	μs
Low Level Clock Pulse Width	t _{LOW}	4.7	-	-	μs
High Level Clock Pulse Width	t _{HIGH}	4.0	-	-	μs
Minimum Start Preparation Waiting Time	t _{SU:STA}	4.7	-	-	μs
Minimum Data Hold Time	t _{HD:DAT}	0	-	3.45	μs
Minimum Data Preparation Time	t _{SU:DAT}	250	-	-	ns
Rise Time	t _R	-	-	1.0	μs
Fall Time	t _F	-	-	300	ns
Minimum Stop Preparation Waiting Time	t _{SU:STO}	4.0	-	-	μs

I²C BUS Load Condition: Pull up resistance 4kΩ (Connected to +5V)
Load capacitance 200pF (Connected to GND)

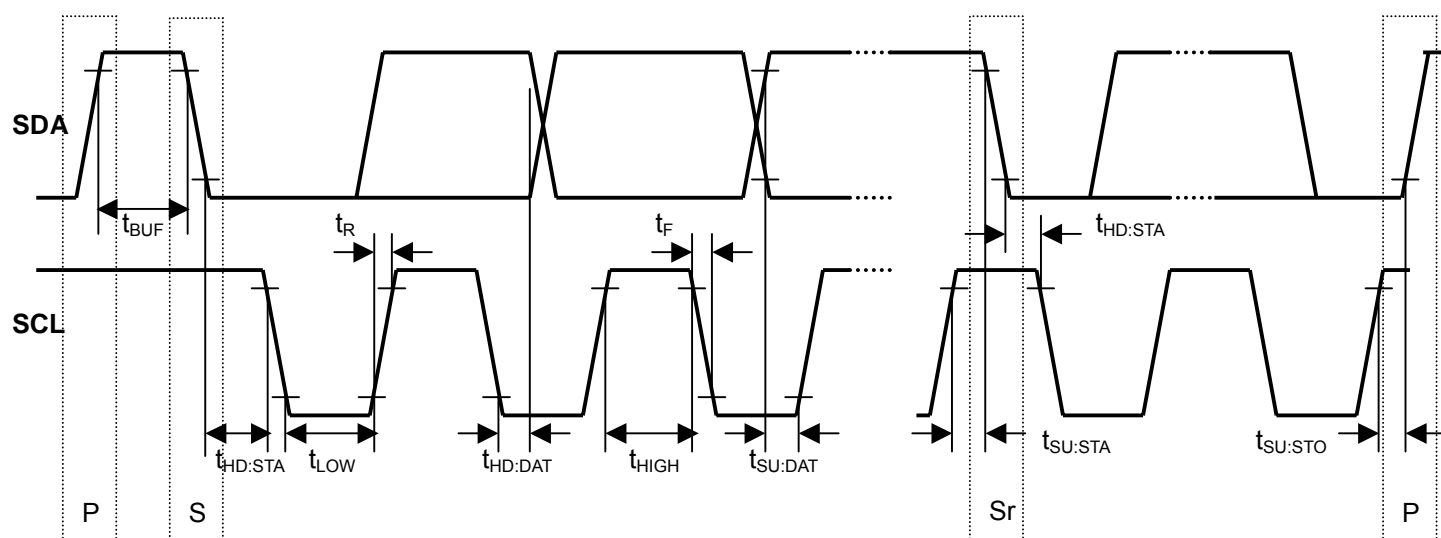

■TERMINAL DESCRIPTION

No.	SYMBOL	FUNCTION	EQUIVALENT CIRCUIT	VOLTAGE
1 30	INa INb	Ach Input terminal Bch Input terminal		V+/2
4 8 23 27	OUT1a OUT2a OUT2b OUT1b	Ach Output for the Other Accessories Ach Output Bch Output Bch Output for the Other Accessories		V+/2
10	SS-FIL	Simulated Stereo Filter terminal		V+/2
6 25	TONE-Ha TONE-Hb	Treble (tone control) filter terminal		V+/2

■TERMINAL DESCRIPTION

No.	SYMBOL	FUNCTION	EQUIVALENT CIRCUIT	VOLTAGE
7 24	TONE-La TONE-Lb	Bass (tone control) filter terminal		V+/2
9	AGC	Capacitor connection terminal for AGC attack and recovery time setting		-
11 12	CVB CVA	Pop Noise Reduction for Volume & Balance		-
13	SDA	I ² C data terminal		-
14	SCL	I ² C clock terminal		-

■TERMINAL DESCRIPTION

No.	SYMBOL	FUNCTION	EQUIVALENT CIRCUIT	VOLTAGE
5 26	IN2a IN2b	Ach Input from the Other Accessories Bch Input from the Other Accessories		V+/2
21	Vref	Reference voltage terminal		V+/2
17 18	AUX0 AUX1	Auxiliary 2 values voltage output terminal		0/5V
20 19	CTH CTL	Pop Noise reduction for Bass Control Pop Noise reduction for Treble Control		-
22	SR-FIL	Surround filter terminal		V+/2
15 16	V+ GND	Ground terminal Supply voltage terminal	-	-

APPLICATION CIRCUIT 1

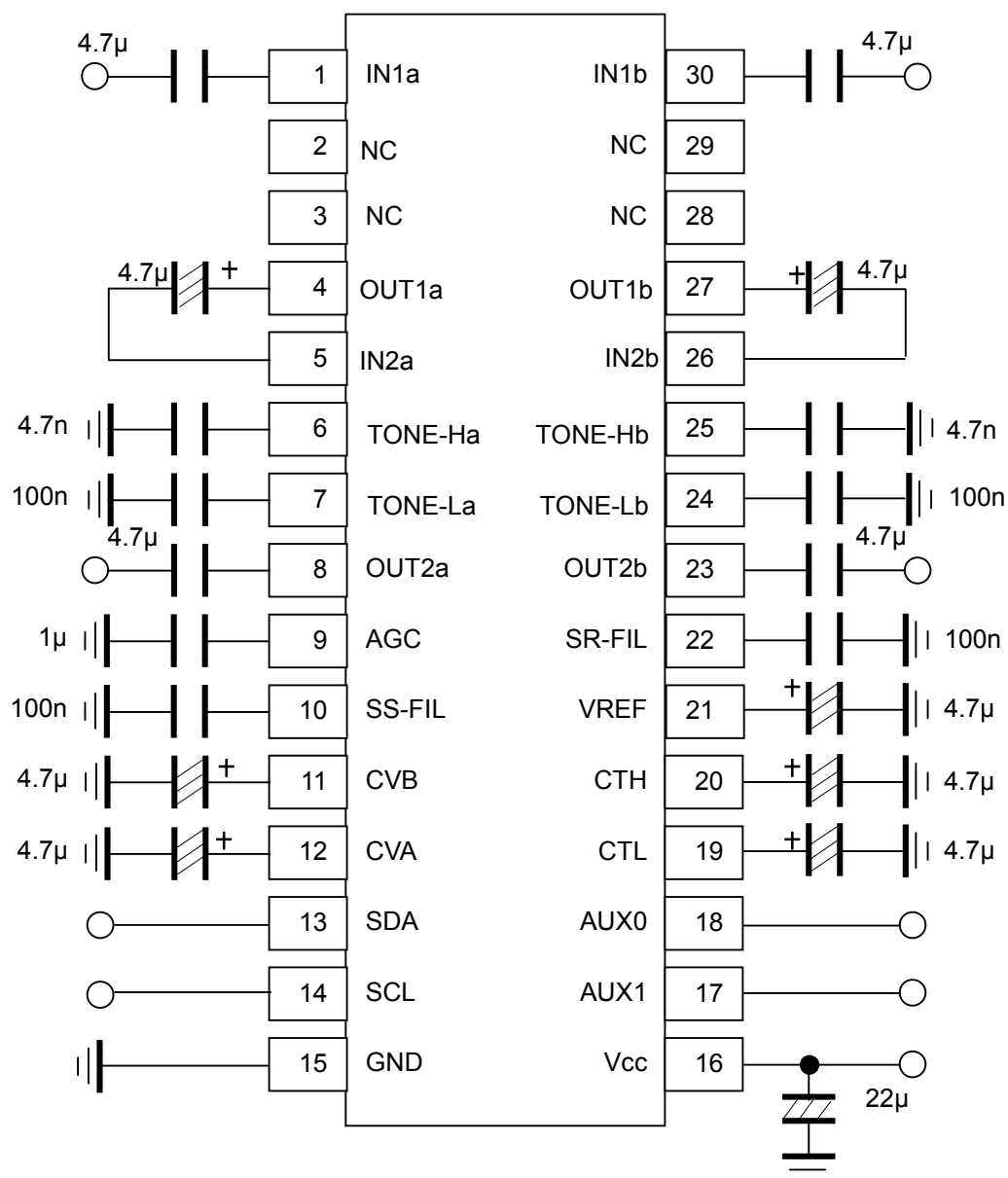

(NOTE)

1. Separate the I²C bus line from the following terminals for avoiding digital noise problem.

Pin No.	Symbol	Pin No.	Symbol	Pin No.	Symbol
6	TONE-Ha	10	SS FIL	24	TONE-Lb
7	TONE-La	22	SR FIL	25	TONE-Hb

APPLICATION CIRCUIT 2

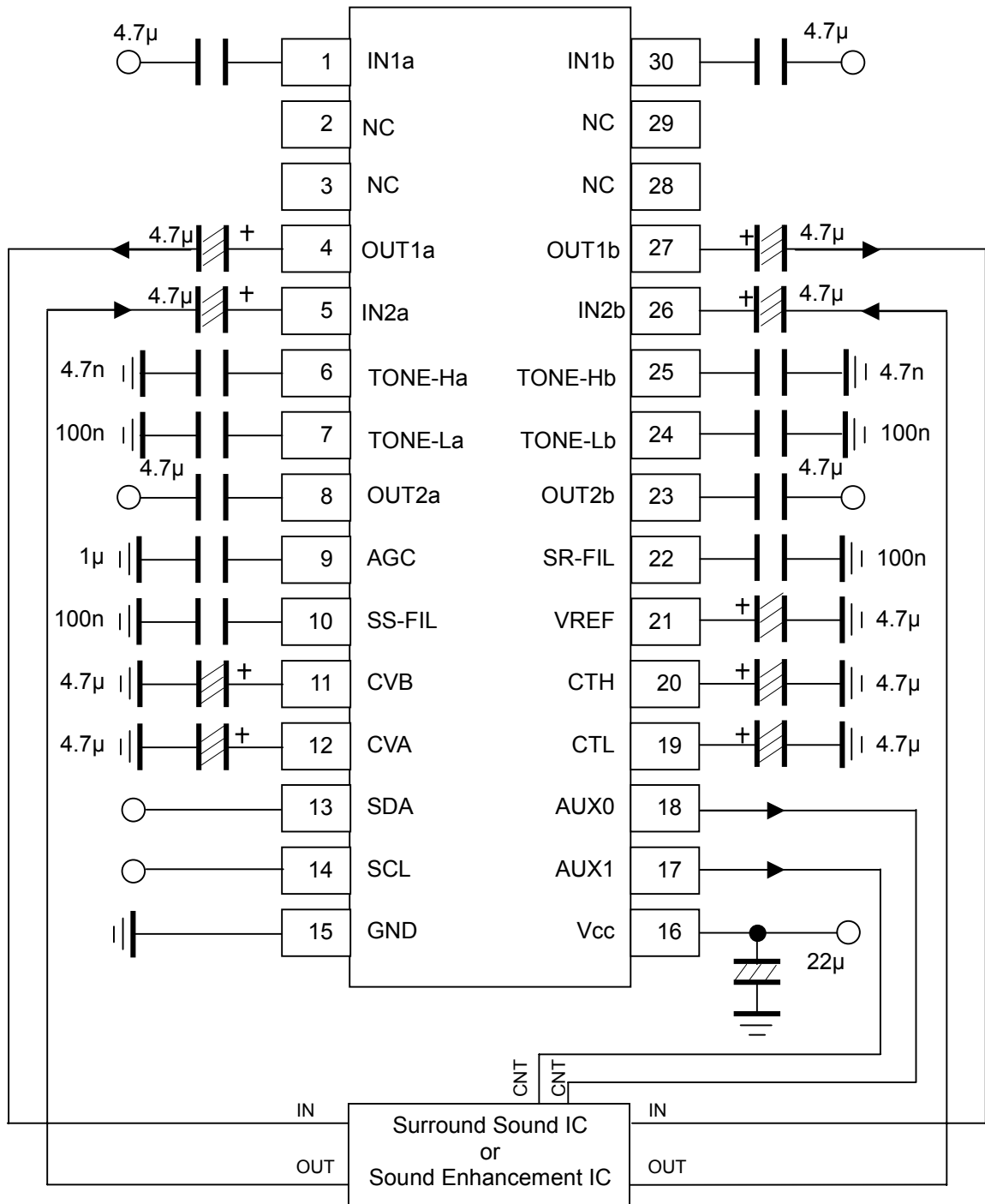

Ex.)
 ealaBASS : NJM2706
 BBE Mach3 : NJM2155
 SRS TruBass : NJM2192A
 SRS WOW : NJM2700, NJM2195, ... , etc

(NOTE)

1. Separate the I²C bus line from the following terminals for avoiding digital noise problem.

Pin No.	Symbol	Pin No.	Symbol	Pin No.	Symbol
6	TONE-Ha	10	SS FIL	24	TONE-Lb
7	TONE-La	22	SR FIL	25	TONE-Hb

APPLICATION NOTE

1. AGC (Auto Gain Control) Circuit

AGC circuit adjusts the input signal level with Boost/Attenuate circuit. AGC boost the low input signal level and attenuate high input signal level automatically.

The AGC flat levels (150mV, 300mV, 400mV and 540mV) are selectable via I²C bus. (Refer to the following figure.)

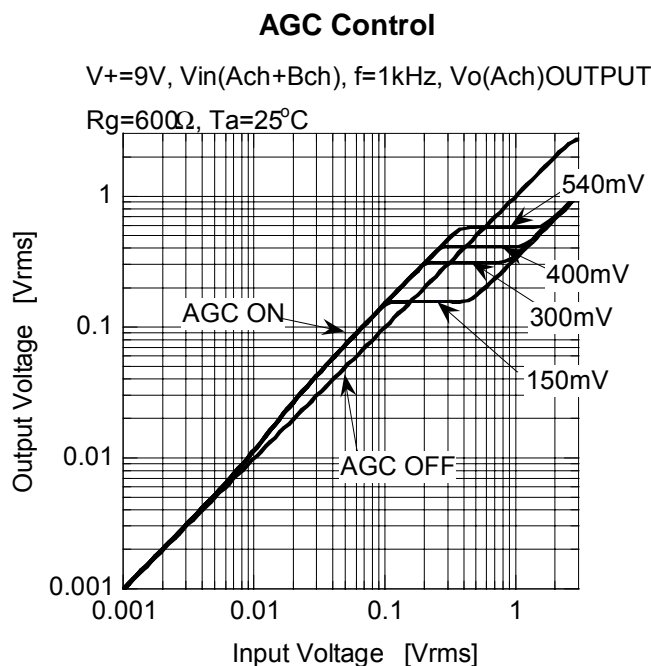

Attack-Recovery

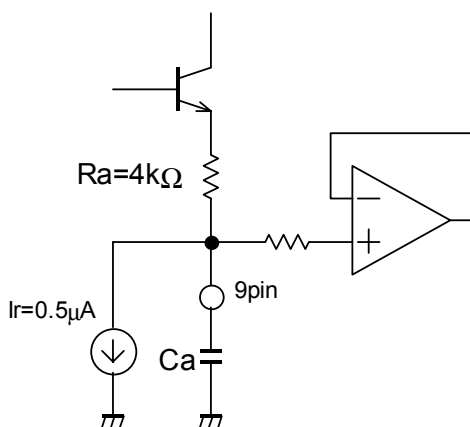

Smoothing circuit of Attenuate

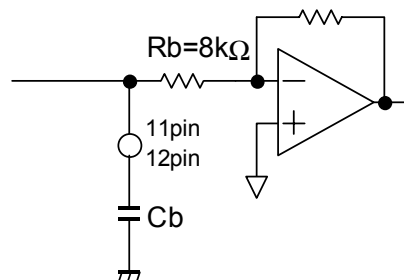

Smoothing circuit of Boost

Attack and recovery time in the attenuation processing depends on external part Ca, and it in the boost processing depends on external part Cb. They become longer as the capacity bigger and become shorter as it gets smaller. (Recommendation value: Ca=1μF, Cb=4.7μF)

Reducing the capacity of Ca may cause the distortion. As for Cb, since it serves as the click noise prevention, reducing the capacity may cause the click noise upon volume changing.

2. Tone Control

a) Bass: Setting the Cut-off frequency

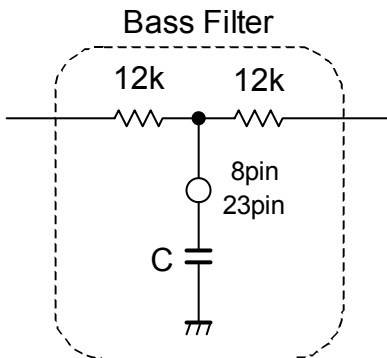

$$f_c = \frac{M}{2\pi \times C \times 12k}$$

M changes by gain setting of Tone.

M ≈ 2.65	(±15dB)
M ≈ 3.45	(±10dB)
M ≈ 8.10	(±5dB)

b) Treble: Setting the Cut-off frequency

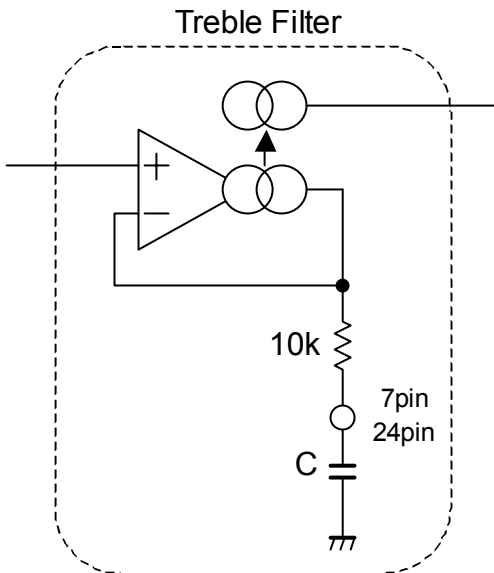

$$f_c = \frac{N}{2\pi \times C \times 10k}$$

N changes by gain setting of Tone.

N ≈ 0.76	(±15dB)
N ≈ 0.58	(±10dB)
N ≈ 0.25	(±5dB)

3. AUX1, AUX0 Terminal

AUX1/0 are enable to control external logic circuit is

Source current	: 1mA typ. (Ta=25°C)
Sink current	: 0.5mA typ. (Ta=25°C)

4. Capacitor for Reference Voltage (21pin)

22μF should be recommended for ripple filter connected to Vref terminal (21pin).

Reducing this capacity may cause to reduce the maximum attenuation level and to increase the output noise.

DEFINITION OF I²C REGISTER

◆ I²C BUS FORMAT



S: Starting Term
A: Acknowledge Bit
P: Ending Term

◆ SLAVE ADDRESS

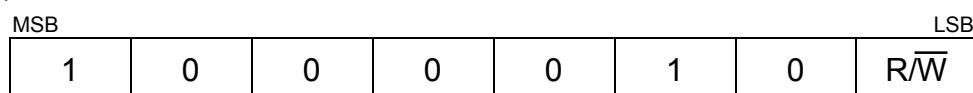

R/W=0: Receive Only
R/W=1: No Output Data

◆ CONTROL REGISTER TABLE

The select address sets each function (Volume, Balance, AGC, Surround, Tone Control, AUX).
The auto increment function cycles the select address as follows.
00H→01H→02H→03H→04H→05H→00H

Select Address	BIT							
	D7	D6	D5	D4	D3	D2	D1	D0
00H	VOL							
01H	CHS	BAL				AGC	SUR	
02H	BCB	BASS			BCSB	SUB-BASS		
03H	BCT	TREB			BCST	SUB-TREB		
04H ^(*)	0	0	0	0	0	0	0	0
05H	OUT	Don't care	Don't care	SUR0	AGC1	AGC0	AUX1	AUX0

(*) Please send the data only "0"

◆ CONTROL REGISTER DEFAULT VALUE

Control register default value is all "0".

Select Address	BIT							
	D7	D6	D5	D4	D3	D2	D1	D0
00H	0	0	0	0	0	0	0	0
01H	0	0	0	0	0	0	0	0
02H	0	0	0	0	0	0	0	0
03H	0	0	0	0	0	0	0	0
04H	0	0	0	0	0	0	0	0
05H	0	0	0	0	0	0	0	0

■INSTRUCTION CODE

a) MASTER VOLUME SETTING

Select Address	BIT							
	D7	D6	D5	D4	D3	D2	D1	D0
00H	VOL							

The volume control for both Ach and Bch (0.33dB/step).

The volume is consisted of volume1 and volume2 and the level is divided into half to each volume1 and volume2.

b) BALANCE, AGC AND SURROUND SETTING

Select Address	BIT							
	D7	D6	D5	D4	D3	D2	D1	D0
01H	CHS	BAL					AGC	SUR

- CHS: Channel select for balance control

“0”: Ach “Bch is attenuated”

“1”: Bch “Ach is attenuated”

- BAL: Balance control for both Ach and Bch (1dB/Step)

The balance is consisted of volume1 and volume2 and the level is divided into half to each volume1 and volume2.

- AGC: AGC switch

“0”: AGC OFF

“1”: AGC ON

- SUR: Surround mode switch

“0”: Surround OFF

“1”: Surround ON

NOTE) The click noise may be generated by changing the Surround mode setting.
Provide the external circuit for avoiding the click noise on above condition.

c) TONE CONTROL BASS SETTING

Select Address	BIT							
	D7	D6	D5	D4	D3	D2	D1	D0
02H	BCB	BASS				BCSB	SUB-BASS	

- BCB: Boost cut select for Bass control

“0”: Cut

“1”: Boost

- BASS: BASS control

Cut Level : -15dB to 0dB(1dB/Step)

Boost Level : 0dB to +15dB(1dB/Step)

- BCSB: Boost cut select for SUB-BASS control

“0”: Cut

“1”: Boost

- SUB-BASS: SUB- BASS control (1dB/Step)

Sub-Cut Level : -3dB to 0dB(1dB/Step)

Sub-Boost Level : 0dB to +3dB(1dB/Step)

d) TONE CONTROL TREBLE SETTING

Select Address	BIT							
	D7	D6	D5	D4	D3	D2	D1	D0
03H	BCT	TREB				BCST	SUB-TREB	

- BCT: Boost cut select for Treble control
 "0": Cut
 "1": Boost
- TREB: Treble control (1dB/step)
 Cut Level : -15dB to 0dB(1dB/Step)
 Boost Level : 0dB to +15dB(1dB/Step)
- BCST: Boost cut select for Sub-Treble control
 "0": Cut
 "1": Boost
- SUB-TREB: Sub-Treble control (1dB/step)
 Sub-Cut Level : -3dB to 0dB(1dB/Step)
 Sub-Boost Level : 0dB to +3dB(1dB/Step)

e) OUTPUT AND AUXILIARY SETTING

Select Address	BIT							
	D7	D6	D5	D4	D3	D2	D1	D0
05H	OUT	Don't Care	Don't Care	SUR0	AGC1	AGC0	AUX1	AUX0

- OUT: ON/OFF Switch for OUTPUT
 "0" : OFF
 "1" : ON

NOTE) The click noise may be generated by changing the "OUT" switch.
 Provide the external circuit for avoiding the click noise on above condition.

•Surround Setting

Surround Function	SUR0(05H:D4)	SUR(01H:D0),	Remarks
Surround OFF	0	0	Input through
Surround Effect1	0	1	Surround Effect Small (8.0dB typ.)
Surround Effect2	1	1	Surround Effect Large (12.7dB typ.)
Simulated Stereo	1	0	For monaural signal input only

NOTE) The click noise may be generated by changing the Surround mode setting.
 Provide the external circuit for avoiding the click noise on above condition.

•AGC Level Setting

AGC Level	AGC1(D3)	AGC0(D2)
150mVrms	0	0
300mVrms	0	1
400mVrms	1	0
540mVrms	1	1

- AUX1/AUX0: Auxiliary port High/Low
 "0": Logic output "Low"
 "1": Logic output "High"

■MASTER VOLUME (Select Address: 00H)

		VOL							
Gain (dB)	HEX	D7	D6	D5	D4	D3	D2	D1	D0
0	FF	1	1	1	1	1	1	1	1
-1	FC	1	1	1	1	1	1	0	0
-2	F9	1	1	1	1	1	0	0	1
-3	F6	1	1	1	1	0	1	1	0
-4	F3	1	1	1	1	0	0	1	1
-5	F0	1	1	1	1	0	0	0	0
-6	ED	1	1	1	0	1	1	0	1
-7	EA	1	1	1	0	1	0	1	0
-8	E7	1	1	1	0	0	1	1	1
-9	E4	1	1	1	0	0	1	0	0
-10	E1	1	1	1	0	0	0	0	1
-11	DE	1	1	0	1	1	1	1	0
-12	DB	1	1	0	1	1	0	1	1
-13	D8	1	1	0	1	1	0	0	0
-14	D5	1	1	0	1	0	1	0	1
-15	D2	1	1	0	1	0	0	1	0
-16	CF	1	1	0	0	1	1	1	1
-17	CC	1	1	0	0	1	1	0	0
-18	C9	1	1	0	0	1	0	0	1
-19	C6	1	1	0	0	0	1	1	0
-20	C3	1	1	0	0	0	0	1	1
-21	C0	1	1	0	0	0	0	0	0
-22	BD	1	0	1	1	1	1	0	1
-23	BA	1	0	1	1	1	0	1	0
-24	B7	1	0	1	1	0	1	1	1
-25	B4	1	0	1	1	0	1	0	0
-26	B1	1	0	1	1	0	0	0	1
-27	AE	1	0	1	0	1	1	1	0
-28	AB	1	0	1	0	1	0	1	1
-29	A8	1	0	1	0	1	0	0	0
-30	A5	1	0	1	0	0	1	0	1
-31	A2	1	0	1	0	0	0	1	0
-32	9F	1	0	0	1	1	1	1	1
-33	9C	1	0	0	1	1	1	0	0
-34	99	1	0	0	1	1	0	0	1
-35	96	1	0	0	1	0	1	1	0
-36	93	1	0	0	1	0	0	1	1
-37	90	1	0	0	1	0	0	0	0
-38	8D	1	0	0	0	1	1	0	1
-39	8A	1	0	0	0	1	0	1	0
-40	87	1	0	0	0	0	1	1	1
-41	84	1	0	0	0	0	1	0	0
-42	81	1	0	0	0	0	0	0	1

■MASTER VOLUME (Select Address: 00H)

		VOL							
Gain (dB)	HEX	D7	D6	D5	D4	D3	D2	D1	D0
-43	7E	0	1	1	1	1	1	1	0
-44	7B	0	1	1	1	1	0	1	1
-45	78	0	1	1	1	1	0	0	0
-46	75	0	1	1	1	0	1	0	1
-47	72	0	1	1	1	0	0	1	0
-48	6F	0	1	1	0	1	1	1	1
-49	6C	0	1	1	0	1	1	0	0
-50	69	0	1	1	0	1	0	0	1
-51	66	0	1	1	0	0	1	1	0
-52	63	0	1	1	0	0	0	1	1
-53	60	0	1	1	0	0	0	0	0
-54	5D	0	1	0	1	1	1	0	1
-55	5A	0	1	0	1	1	0	1	0
-56	57	0	1	0	1	0	1	1	1
-57	54	0	1	0	1	0	1	0	0
-58	51	0	1	0	1	0	0	0	1
-59	4E	0	1	0	0	1	1	1	0
-60	4B	0	1	0	0	1	0	1	1
-61	48	0	1	0	0	1	0	0	0
-62	45	0	1	0	0	0	1	0	1
-63	42	0	1	0	0	0	0	1	0
-64	3F	0	0	1	1	1	1	1	1
-65	3C	0	0	1	1	1	1	0	0
-66	39	0	0	1	1	1	0	0	1
-67	36	0	0	1	1	0	1	1	0
-68	33	0	0	1	1	0	0	1	1
-69	30	0	0	1	1	0	0	0	0
-70	2D	0	0	1	0	1	1	0	1
-71	2A	0	0	1	0	1	0	1	0
-72	27	0	0	1	0	0	1	1	1
-73	24	0	0	1	0	0	1	0	0
-74	21	0	0	1	0	0	0	0	1
-75	1E	0	0	0	1	1	1	1	0
-76	1B	0	0	0	1	1	0	1	1
-77	18	0	0	0	1	1	0	0	0
-78	15	0	0	0	1	0	1	0	1
-79	12	0	0	0	1	0	0	1	0
-80	0F	0	0	0	0	1	1	1	1
-81	0C	0	0	0	0	1	1	0	0
-82	09	0	0	0	0	1	0	0	1
-83	06	0	0	0	0	0	1	1	0
-84	03	0	0	0	0	0	0	1	1
Mute	00	0	0	0	0	0	0	0	0

■BALANCE (Select Address: 01H)

Channel Select (CHS)	D7
Ach (Bch is attenuated)	0
Bch (Ach is attenuated)	1

Gain (dB)	BAL				
	D6	D5	D4	D3	D2
0	0	0	0	0	0
-1	0	0	0	0	1
-2	0	0	0	1	0
-3	0	0	0	1	1
-4	0	0	1	0	0
-5	0	0	1	0	1
-6	0	0	1	1	0
-7	0	0	1	1	1
-8	0	1	0	0	0
-9	0	1	0	0	1
-10	0	1	0	1	0
-11	0	1	0	1	1
-12	0	1	1	0	0
-13	0	1	1	0	1
-14	0	1	1	1	0
-15	0	1	1	1	1
-16	1	0	0	0	0
-17	1	0	0	0	1
-18	1	0	0	1	0
-19	1	0	0	1	1
-20	1	0	1	0	0
-21	1	0	1	0	1
-22	1	0	1	1	0
-23	1	0	1	1	1
-24	1	1	0	0	0
-25	1	1	0	0	1
-26	1	1	0	1	0
-27	1	1	0	1	1
-28	1	1	1	0	0
-29	1	1	1	0	1
-30	1	1	1	1	0
Mute	1	1	1	1	1

■TONE CONTROL BASS (Select Address: 02H)

Bass Cut or Boost	BCB
	D7
Cut	0
Boost	1

		BASS			
		D6	D5	D4	D3
Cut Gain (dB)	Boost Gain (dB)				
-15	15	1	1	1	1
-14	14	1	1	1	0
-13	13	1	1	0	1
-12	12	1	1	0	0
-11	11	1	0	1	1
-10	10	1	0	1	0
-9	9	1	0	0	1
-8	8	1	0	0	0
-7	7	0	1	1	1
-6	6	0	1	1	0
-5	5	0	1	0	1
-4	4	0	1	0	0
-3	3	0	0	1	1
-2	2	0	0	1	0
-1	1	0	0	0	1
0	0	0	0	0	0

■TONE CONTROL SUB-BASS (Select Address: 02H)

Sub-Bass Cut or Boost	BCSB
	D2
Cut	0
Boost	1

		SUB-BASS	
		D1	D0
Cut Gain (dB)	Boost Gain (dB)		
-3	3	1	1
-2	2	1	0
-1	1	0	1
0	0	0	0

■TONE CONTROL TREBLE (Select Address: 03H)

Treble Cut or Boost	BCT
	D7
Cut	0
Boost	1

		TREB			
		D6	D5	D4	D3
Cut Gain (dB)	Boost Gain (dB)				
-15	15	1	1	1	1
-14	14	1	1	1	0
-13	13	1	1	0	1
-12	12	1	1	0	0
-11	11	1	0	1	1
-10	10	1	0	1	0
-9	9	1	0	0	1
-8	8	1	0	0	0
-7	7	0	1	1	1
-6	6	0	1	1	0
-5	5	0	1	0	1
-4	4	0	1	0	0
-3	3	0	0	1	1
-2	2	0	0	1	0
-1	1	0	0	0	1
0	0	0	0	0	0

■TONE CONTROL SUB-TREBLE (Select Address : 03H)

Sub-Treble Cut or Boost	BCST
	D2
Cut	0
Boost	1

		SUB-TREB	
		D1	D1
Cut Gain (dB)	Boost Gain (dB)		
-3	3	1	1
-2	2	1	0
-1	1	0	1
0	0	0	0

■TYPICAL CHARACTERISTICS

Supply Current vs Supply Voltage

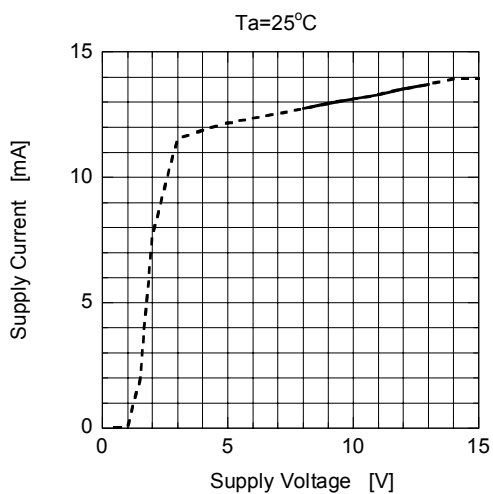

Supply Current vs Temperature

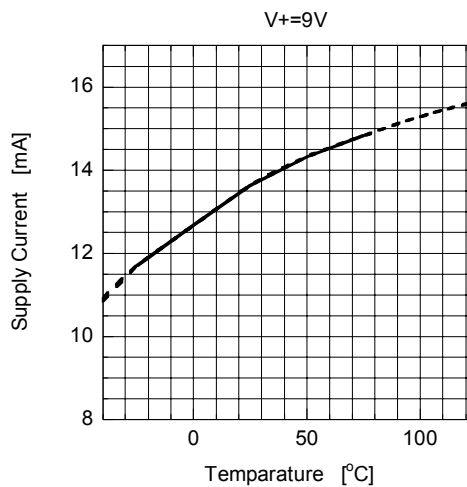

Gain vs Volume Control

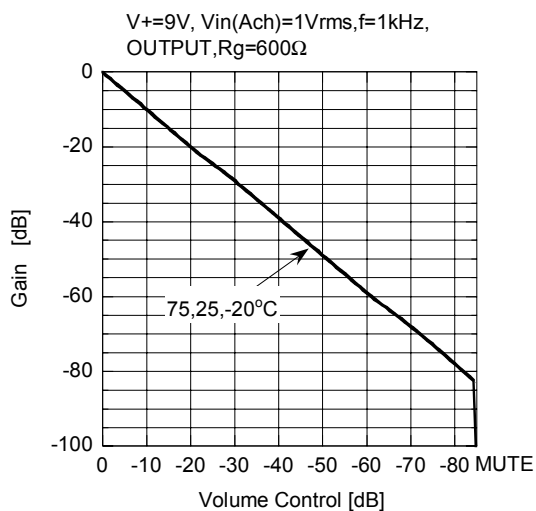

Gain vs Balance Control

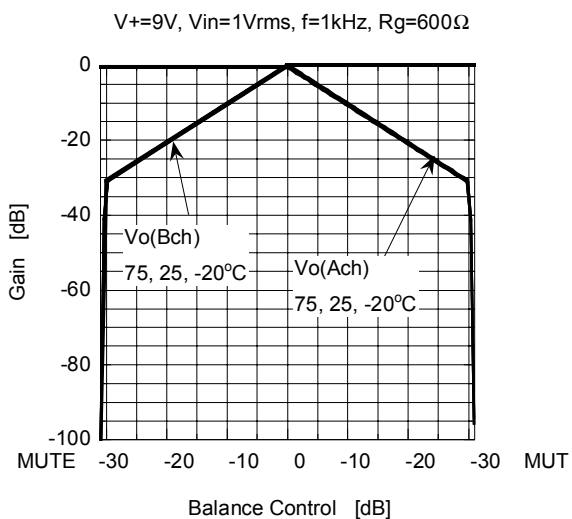

Output Noise vs Volume Control

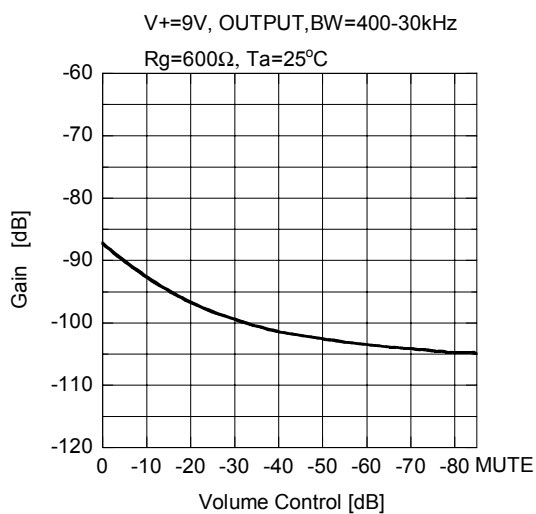

Output Noise vs Temperature

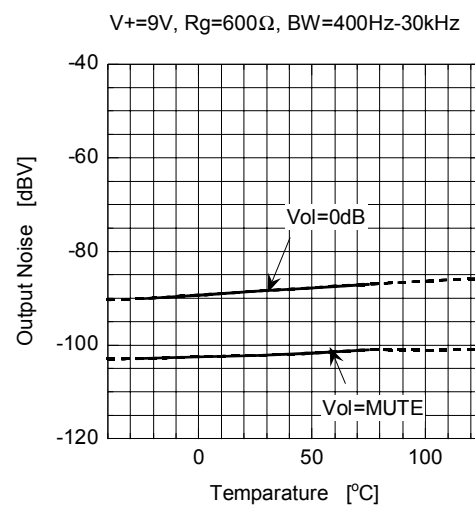

■TYPICAL CHARACTERISTICS

THD+N vs Input Voltage

V+=9V, Vin(Ach), f=1kHz, Vo(Ach)OUTPUT
Rg=600Ω, BW=400Hz-30kHz, Ta=25°C

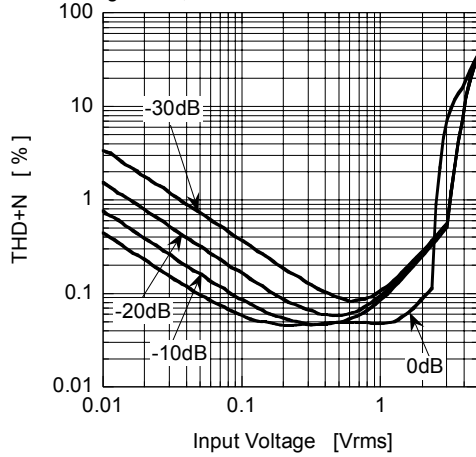

THD+N vs Input Voltage

V+=9V, Vin(Ach), f=1kHz, Vo(Ach)OUTPUT
Rg=600Ω, BW=400Hz-30kHz, Vol=-20dB

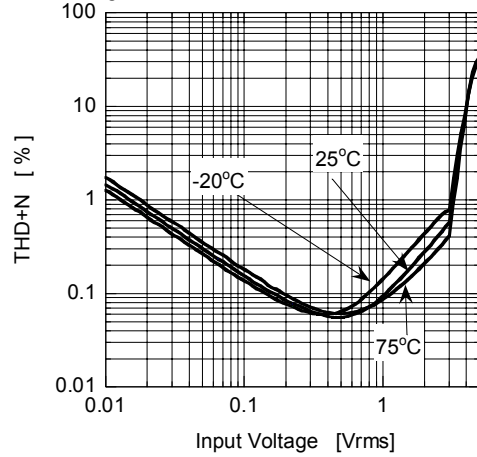

THD+N vs Output Voltage

V+=9V, Vin(Ach), f=1kHz, Vo(Ach)OUTPUT
BW=400Hz-30kHz, Rg=600Ω, Ta=25°C

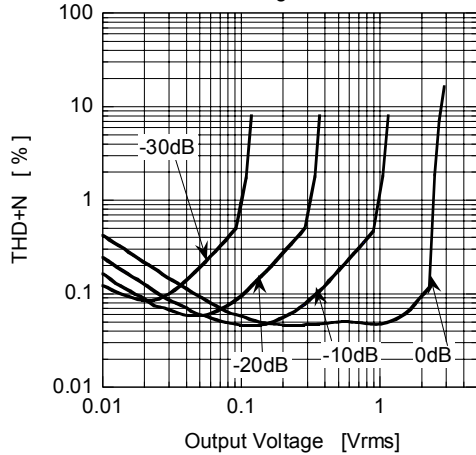

THD+N vs Output Voltage

V+=9V, Vin(Ach), f=1kHz, Vo(Ach)OUTPUT
Rg=600Ω, BW=400Hz-30kHz, Vol=0dB

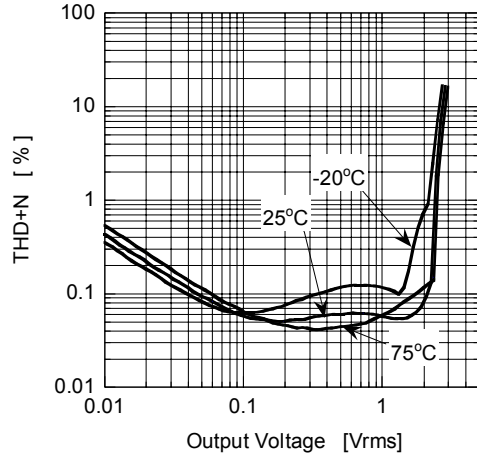

MUTE Level vs Frequency

V+=9V, Vin(Ach)=1Vrms, Vol=MUTE
Vo(Ach)OUTPUT, Rg=600Ω, Ta=25°C

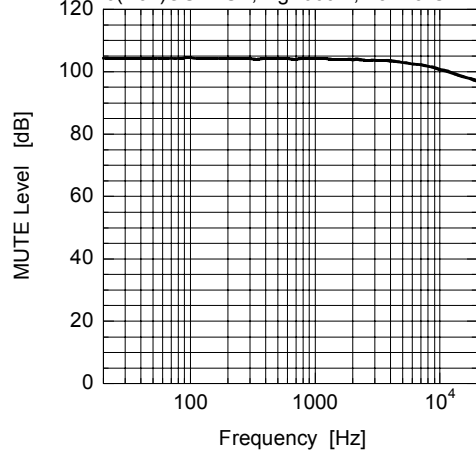

Channel Separation vs Frequency

V+=9V, Vin=2Vrms, f=1kHz, Vo=OUTPUT
Rg=600Ω, Vol=0dB, Ta=25°C

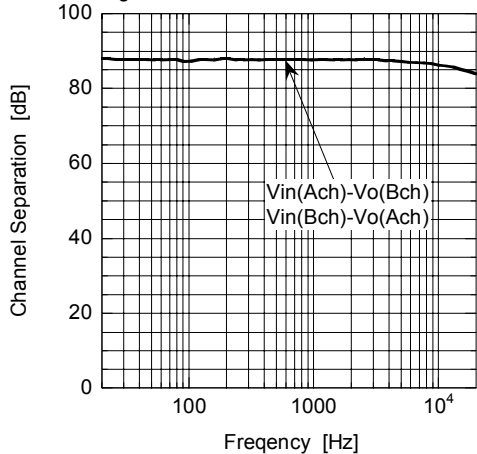

■ TYPICAL CHARACTERISTICS

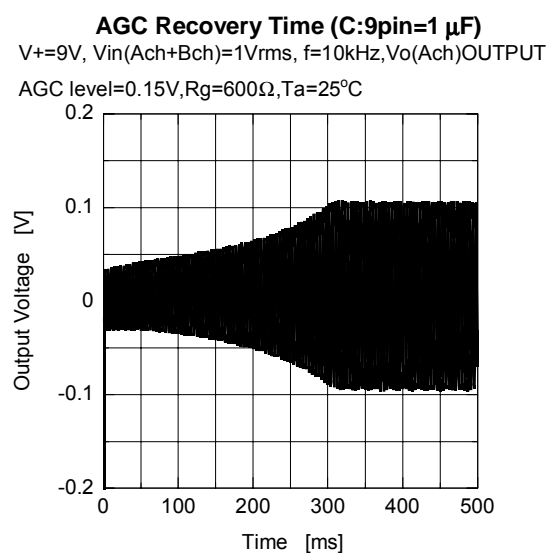
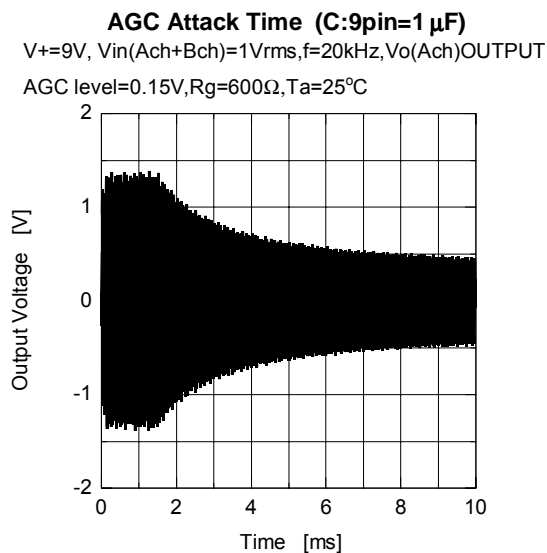
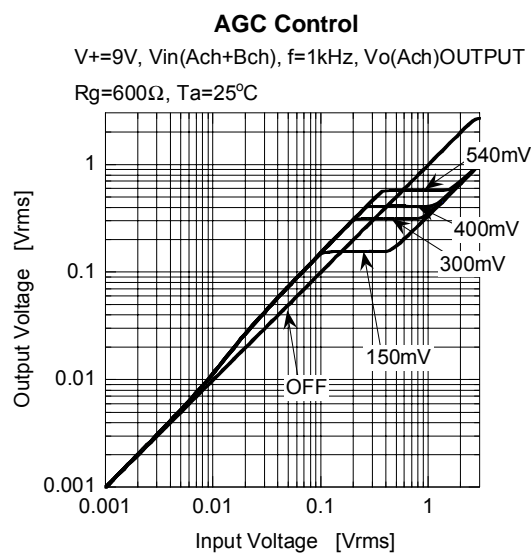
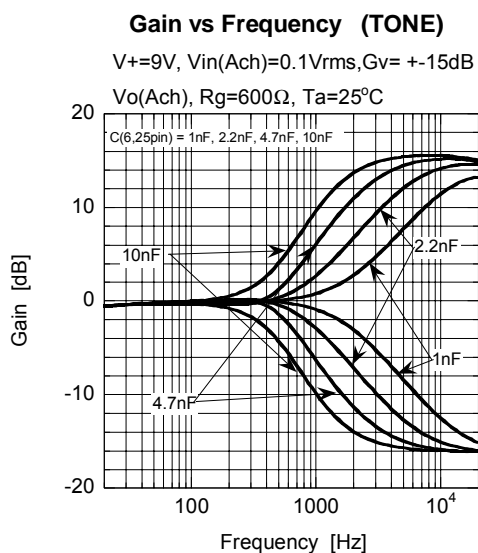
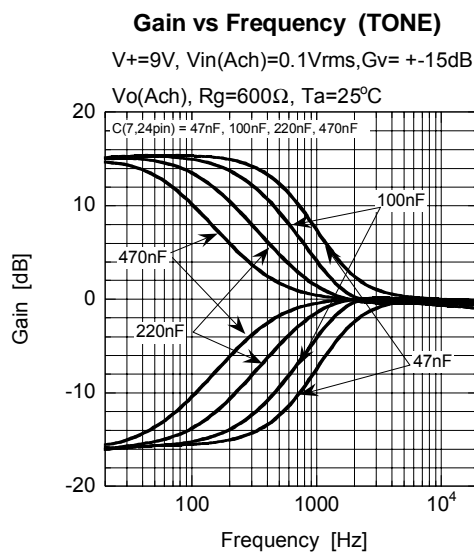
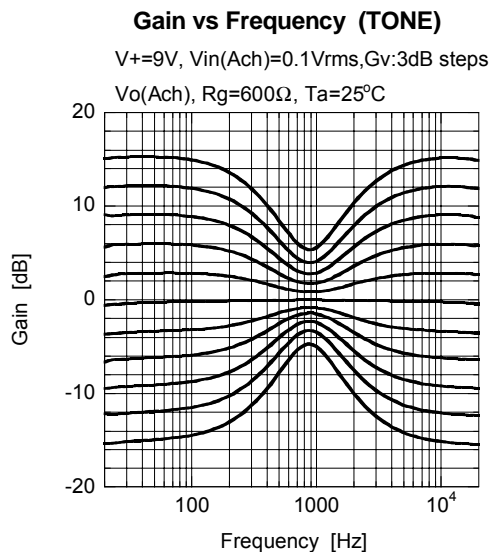

■TYPICAL CHARACTERISTICS

AGC Attack Time (C:9pin=2.2 μF)

V+=9V, Vin(Ach+Bch)=1Vrms, f=20kHz, Vo(Ach)OUTPUT
AGC level=0.15V, Rg=600Ω, Ta=25°C

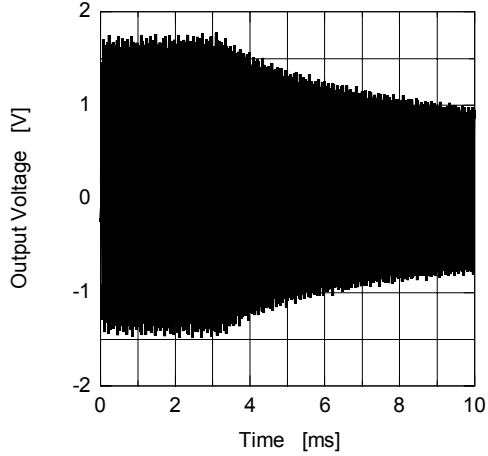

AGC Recovery Time (C:9pin=2.2 μF)

V+=9V, Vin(Ach+Bch)=1 to 0.05Vrms, f=10kHz,
Vo(Ach)OUTPUT, AGC level=0.15V, Rg=600Ω, Ta=25°C

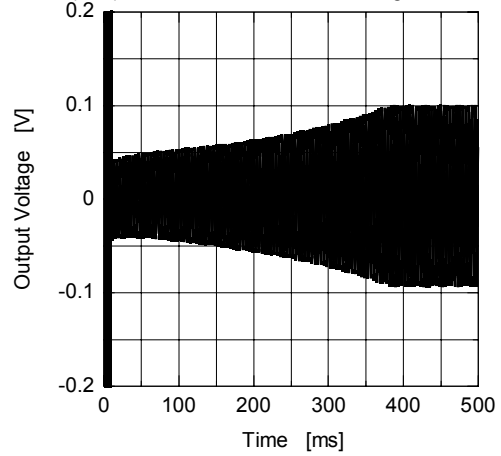

AGC Attack Time (C:9pin=0.47 μF)

V+=9V, Vin(Ach+Bch)=1Vrms, f=20kHz, Vo(Ach)OUTPUT
AGC level=0.15V, Rg=600Ω, Ta=25°C

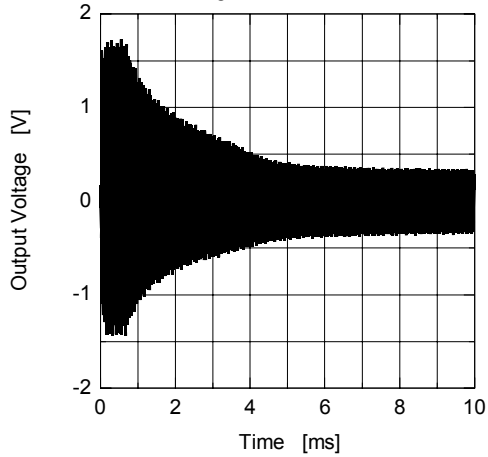

AGC Recovery Time (C:9pin=0.47 μF)

V+=9V, Vin(Ach+Bch)=1 to 0.05Vrms, f=10kHz,
Vo(Ach)OUTPUT, AGC level=0.15V, Rg=600Ω, Ta=25°C

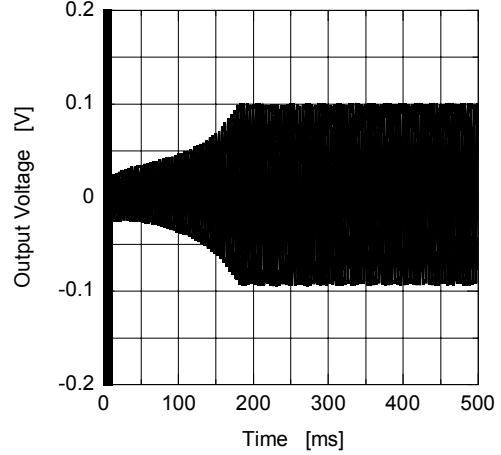

Gain vs Frequency (eala&Simulated)

V+=9V, Vin=0.1Vrms, OUTPUT, Rg=600Ω,
Ta=25°C

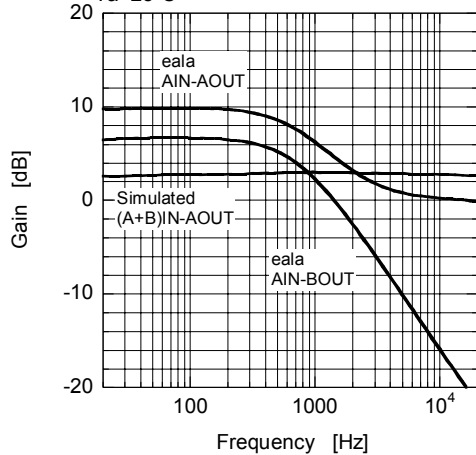

Phase vs Frequency (Simulated)

V+=9V, Vin(A+Bch)=0.1Vrms, Rg=600Ω,
Ta=25°C

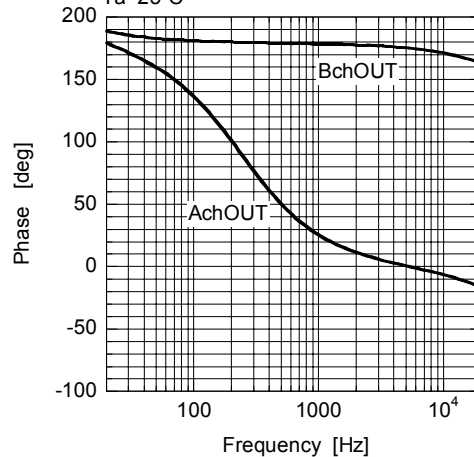

■NOTE

[CAUTION]

The specifications on this databook are only given for information, without any guarantee as regards either mistakes or omissions. The application circuits in this databook are described only to show representative usages of the product and not intended for the guarantee or permission of any right including the industrial rights.